

CAPITOLO 9

MÜLLER Fissaggio



Griglie di areazione



Griglia di areazione

plastica bianca

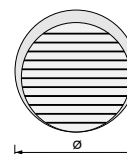

Ø	Codice
60	5200 001 001



Griglia di areazione

acciaio ottonato nichelato

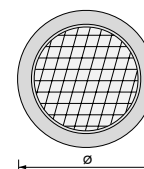

Ø	Finitura	Codice
43	Ottonata	2131 G01 056
43	Nichelata	2131 G01 058

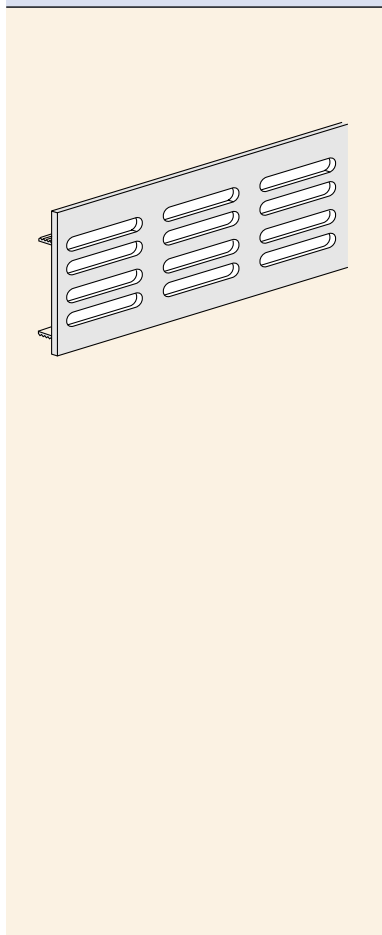

Griglia d'areazione

Alluminio anodizzato argento

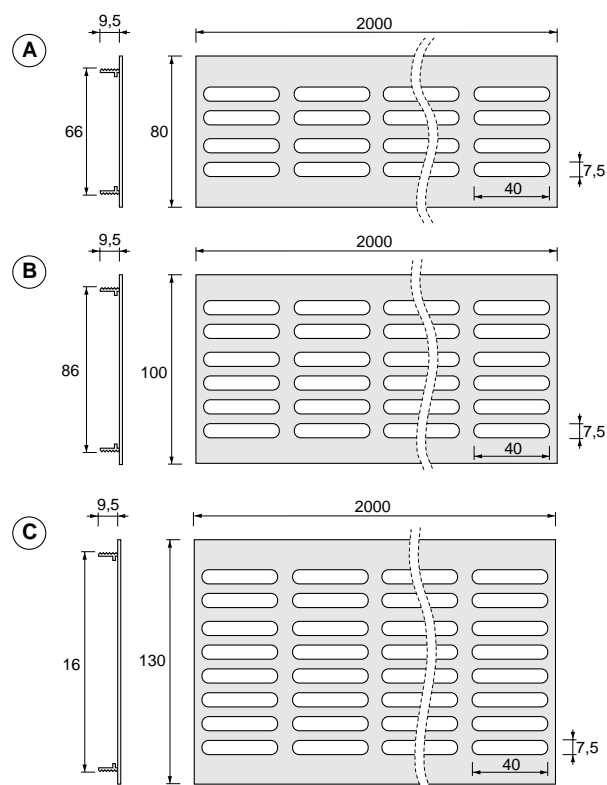

Tipo	Codice
A	5200 010 003
B	5200 010 004
C	5200 010 005

Lampade neon



Lampada al neon 8W/230V

montaggio a battuta
comprensiva di trasformatore silenzioso interno

Finitura	Codice
Bianca	2406 001 030
Marrone	2406 001 010

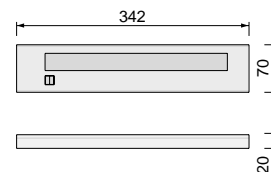

Lampada al neon 13W/230V

montaggio a battuta
comprensiva di trasformatore silenzioso interno

Finitura	Codice
Bianca	2406 001 023
Marrone	2406 001 003

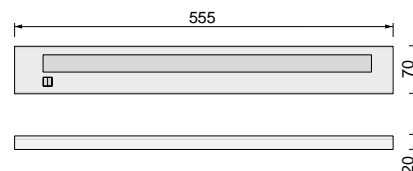

Lampada al neon 8W/230V-Incasso

montaggio incasso
comprensiva di trasformatore silenzioso interno

Finitura	Codice
Bianca	2406 001 026
Marrone	2406 001 008

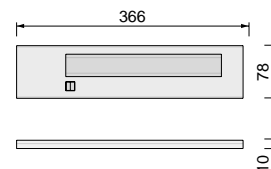

Lampada al neon 13W/230V-Incasso

montaggio incasso
comprensiva di trasformatore silenzioso interno

Finitura	Codice
Bianca	2406 001 021
Marrone	2406 001 001

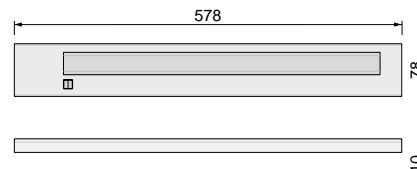

Cavo di alimentazione

lunghezza 2 metri

Codice
2406 001 049

NOTE

Le tipologie di lampade sopra descritte possono essere collegate sia in linea che in parallelo.
Sono da richiedere gli accessori di montaggio.

Faretti a bassa tensione



Faretto a bassa tensione

acciaio
vetro sabbato

Finitura	Codice
Ottonata	2407 101 111
Cromata	2407 101 112
Nera	2407 101 113

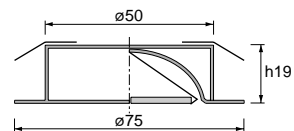

Faretto a bassa tensione

acciaio
vetro trasparente

Finitura	Codice
Ottonata	2407 101 121
Cromata	2407 101 122
Nera	2407 101 123

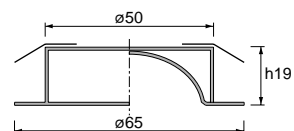

Faretto a bassa tensione

acciaio
vetro sabbato

Finitura	Codice
Ottonata	2407 101 131
Cromata	2407 101 132
Nera	2407 101 133

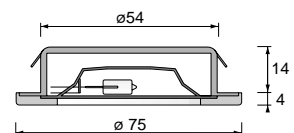

Faretto a bassa tensione

acciaio
vetro trasparente

Finitura	Codice
Ottonata	2407 101 141
Cromata	2407 101 142
Nera	2407 101 143

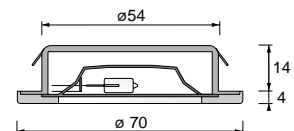

Trasformatore 100W/230V

per faretti a bassa tensione

Codice
2407 001 008

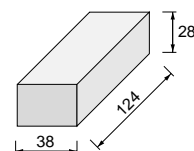

Faretti



Faretto alogeno per mobili ad ante battenti 10W/12V

In materiale plastico.
Trasformatore incorporato e vetro protettivo.
Spegnimento automatico alla chiusura dell'anta.
Completo di lampada alogena e di cavo di alimentazione con attacco rapido.

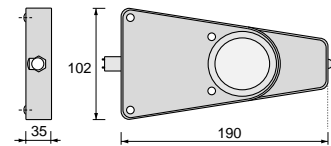
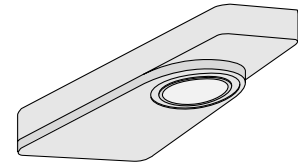

Finitura	Codice
Bianca	2407 101 150
Nera	2407 101 151
Lampadina E	2407 101 152



Armature con lampada fluorescente

Adatte per sottopensili.
Realizzate in materiale termostampato.
Basso consumo di energia e alta resa luminosa.
Completo di cavo d'alimentazione (2 mt.) e spina Europea.
Completo di tubo fluorescente 220 v.

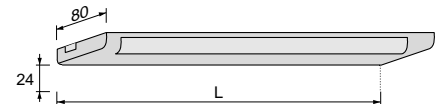
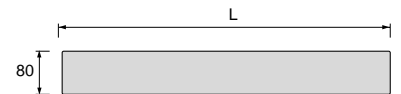

Potenza	L/mm	Codice	
		Bianca	Nera
8w	345	2407 101 153	2407 101 155
13w	570	2407 101 154	2407 101 156



Lampada alogena rotante

per anta a battente e anta scorrevole
Nylon e metallo
potenza 20W 12V completo di trasformatore da 230/12V

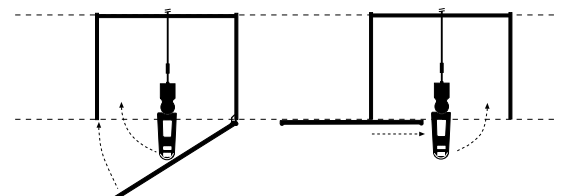
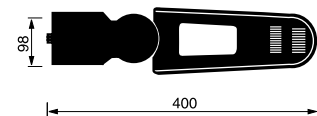
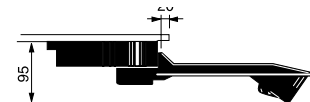

Finitura	Codice
Bianca	2407 164 201
Nera	2407 164 203

Tubi e reggitubi

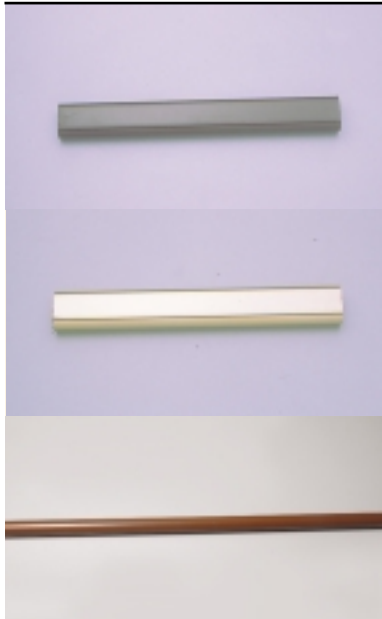

Tubo per armadi

Acciaio ovale

H	X	L	Finitura	Codice
30	15	3000	oro	2134 006 025
30	15	3000	cromo	2134 006 022
25	15	3000	oro	2134 007 000
25	15	3000	cromo	2134 007 001
22	15	3000	oro	2134 007 002
22	15	3000	cromo	2134 007 003

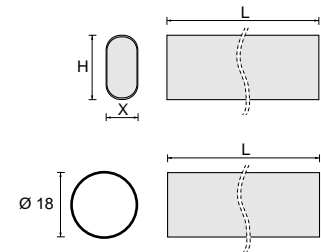

Acciaio plastificato tondo

Ø	L	Finitura	Codice
18	807	bianco	2134 008 071
18	807	marrone	2134 008 072
18	864	marrone	2134 008 073



Tubo per armadi

Alluminio ovale

H	X	L	Finitura	Codice
30	15	3000	anodiz. argento	2134 009 001
30	15	3000	anodiz. oro	2134 009 002

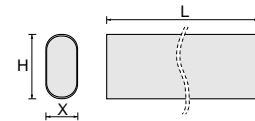

Reggitubo fissaggio a squadra

zama - 2 fori

Finitura	Codice
oro	2135 0F1 020
cromo	2135 0F1 010

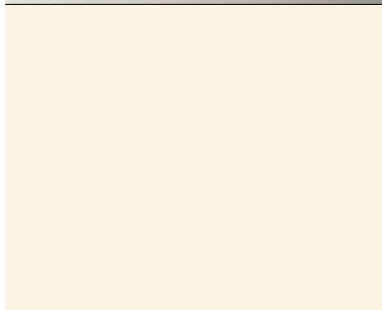
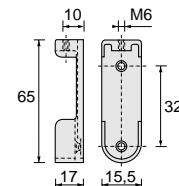

Reggitubo fissaggio a spalla

zama - 3 fori

Finitura	Codice
oro	2135 0F1 015
cromo	2135 0F1 016

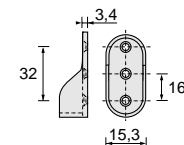

Reggitubo fissaggio a spalla

zama - 2 perni

Finitura	Codice
oro	2135 0F1 017
cromo	2135 0F1 018

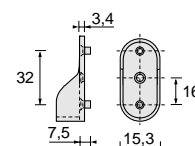

Tubi e reggitubi



Reggitubi regolabili zama

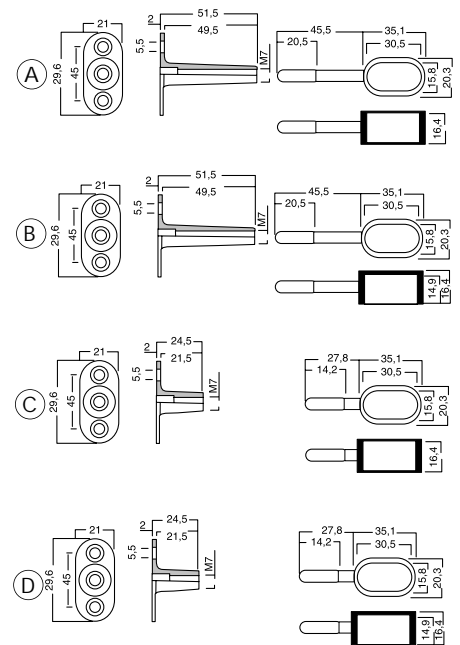

Tipo	Forma	Finitura	Codice
A	Aperto	Oro	2135 003 002
A	Aperto	Cromo	2135 003 005
B	Chiuso	Oro	2135 0D2 017
B	Chiuso	Cromo	2135 0D2 016
C	Aperto	Oro	2135 003 001
C	Aperto	Cromo	2135 003 004
D	Chiuso	Oro	2135 0D2 015
D	Chiuso	Cromo	2135 0D2 014

La tipologia A e la tipologia B hanno regolazione da 84 a 112 mm
La tipologia C e la tipologia D hanno regolazione da 65 a 80 mm



Reggitubo fissaggio a squadra

Nylon con dado zincato a 2 fori

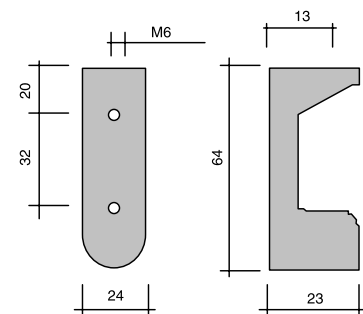

Tipo	Finitura	Codice
A	Bianco	
A	Nero	2135 0A1 007
A	Noce	
B	Bianco	2135 0A1 009
B	Nero	
B	Noce	

La tipologia A per tubo da diametro 18
La tipologia B per tubo 30 x 15



Reggitubo fissaggio a squadra

Nylon

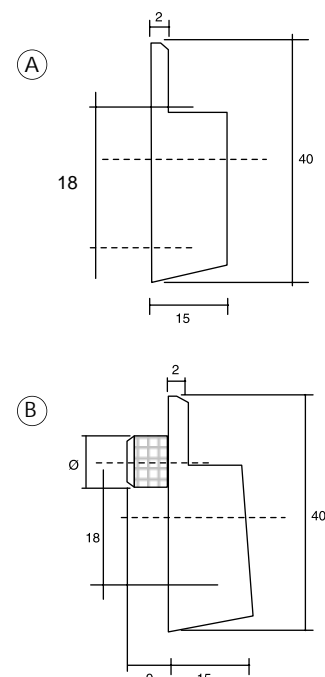

Tipo	Fissaggio	Finitura	Codice
A	2 fori	Bianco	
A	2 fori	Noce	2135 0A1 002
B	prem. Ø10	Bianco	2135 0A1 004
B	prem. Ø10	Noce	2135 0A1 005
B	prem. Ø8	Bianco	2135 0A1 008
B	prem. Ø8	Noce	

La tipologia A con 2 fori
La tipologia B con premontaggio

Appendiabiti

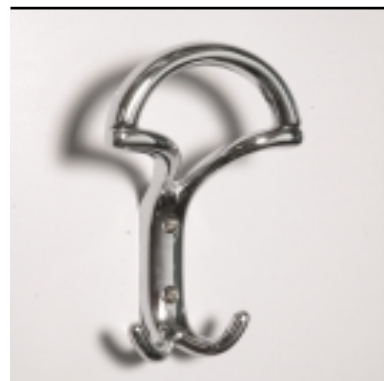

Appendiabiti
zama

Finitura	Codice
Cromato	2120 799 501
Ottonato	2120 799 500

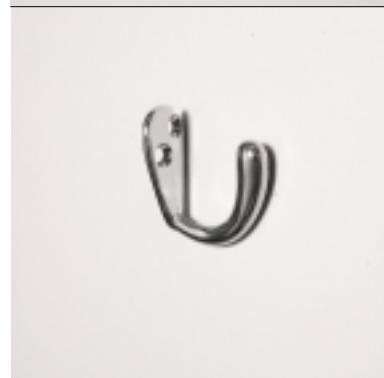
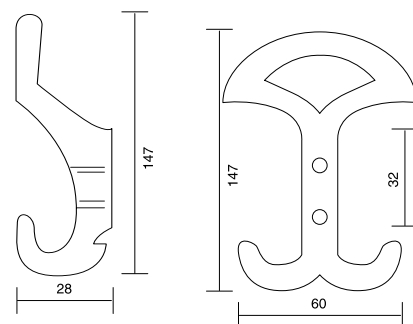

Gancio appendiabiti
zama

Finitura	Codice
Cromato	2120 801 001
Ottonato	2120 801 000



Appendiabiti
finitura in alluminio pressofuso e laccato con polveri epossidiche

Finitura	Codice
bianca	2132 051 562
nera	2132 052 562

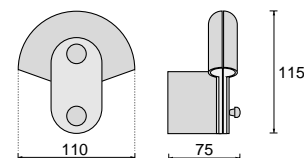

Appendiabiti (Trio)
finitura oro lucido, oro zecchino, cromo

Finitura	Codice
oro lucido	1919 CB1 700

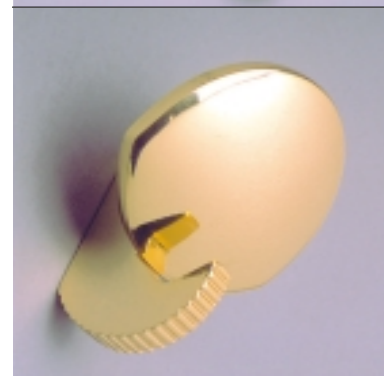
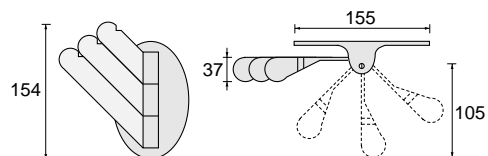

Appendiabiti (Disco)
finitura oro lucido, oro zecchino, cromo

Finitura	Codice
oro zecchino	1919 CA2 700
oro zecchino	1919 CA3 700
cromo	1919 OCA 370

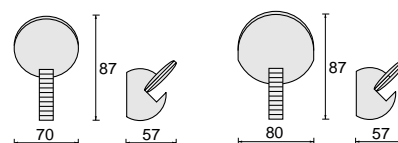

Portascarpe - scolapiatti - reti



Portascarpe

filo metallico

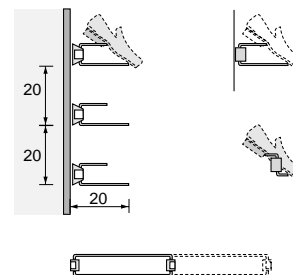

Dimensione	Codice
48 - 83	2133 001 002
83 - 113	2133 001 003



Scolapiatti Inox

Acciaio inox 18/8

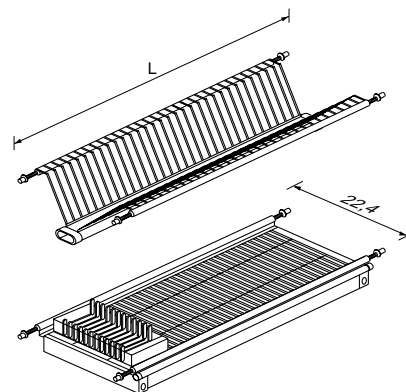

L	Codice
40	500 000 3040
50	500 000 3050
60	500 000 3060
70	500 000 3070
80	500 000 3080
90	500 000 3090
100	500 000 3100



Rete singola ribaltabile per ante in luce

Metallo e legno

Tipologia	Codice
Singola	9000 007 001
Matrimoniale	9000 007 000

Misure a richiesta

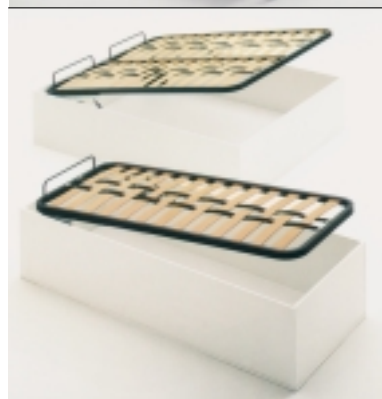

Rete basculante

Metallo e legno

Tipologia	Codice
Singola	9000 008 001
Matrimoniale	9000 008 000

Misure a richiesta

Passamaneria

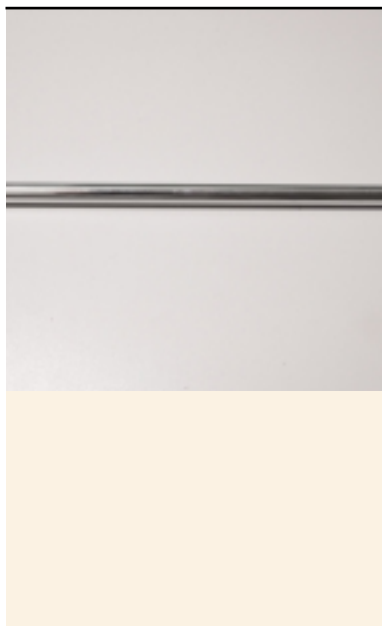

Tubo tondo

ottone cromato

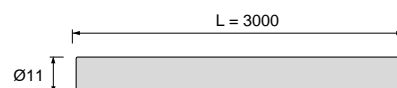

Misura	Codice
11 x 3000	2097 000 011



Tappo

ottone cromato

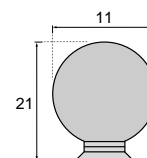

Misura	Codice
11 x 21	2131 883 110

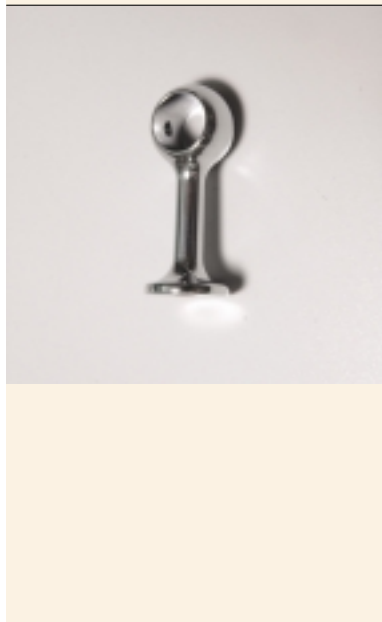

Passatubo

ottone cromato

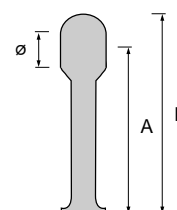

A	B	Ø	Codice
40	50	11	2131 844 000
70	80	11	2131 844 001

Stucchi cere ritocchi

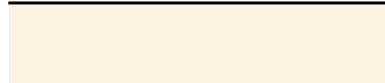

Stucco per legno

Materiale ideale per la ristrutturazione di legni difettati e danneggiati
Confezioni da 750 grammi

Caratteristiche:
essiccazione superficiale 1 ora - completa 12 ore
carteggiabile dopo 6 ore
diluente: nitro o acetone

Colore	Codice
Teak	1009 000 240
Mogano	1009 000 241
Rovere	1009 000 242
Pioppo	1009 000 243
Noce scuro	1009 000 244
Noce chiaro	1009 000 245
Ciliegio	1009 000 246
Douglas	1009 000 247
Bianco	1009 000 248
Frassino	1009 000 249

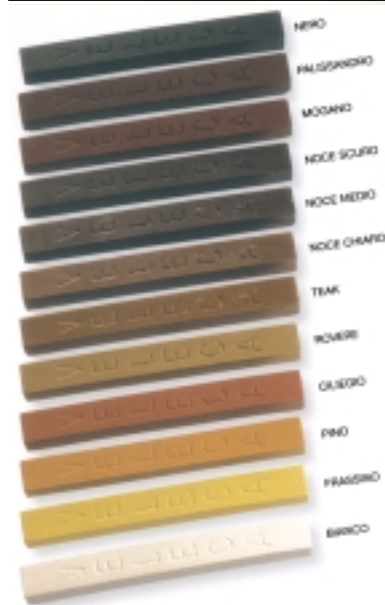

Bastoncini cera

Materiale ideale per riparare graffi profondi
Confezioni box in PVC

Caratteristiche:
essiccazione superficiale 1 ora - completa 12 / 24 ore
dopo 2 - 3 minuti togliere l'eccesso
di prodotto con un panno

Colore	Codice
Nero	1009 000 204
Ciliegio	1009 000 208
Bianco	1009 000 210
Frassino	1009 000 211
Teak	1009 000 212
Pino	1009 000 213
Rovere	1009 000 214
Noce chiaro	1009 000 215
Noce medio	1009 000 216
Noce scuro	1009 000 217
Mogano	1009 000 218
Palissandro	1009 000 219



Pennarelli per ritocchi

Materiale ideale per riparare graffi superficiali
Confezione scatole da 12 pezzi

Caratteristiche:
tingente per legno in soluzione alcolica



Colore	Codice
Ciliegio	1009 000 346
Frassino	1009 000 353
Rovere	1009 000 354
Noce chiaro	1009 000 355
Noce medio	1009 000 356
Mogano	1009 000 357
Nero	1009 000 379
Assortiti 48 pz	1009 000 382