



**VITE TESTA SVASATA CALOTTA AUTOFORANTE PER PVC PER FISSAGGIO DI RINFORZI E CERNIERE**

CODICE	Ø x L	FINITURA	CAPACITÀ DI FORATURA	LUNGHEZZA UTILE
0088 039 013	D. 3,9 x 13	ZINCATA	3 MM	6 MM
0088 039 016	D. 3,9 x 16	ZINCATA	3 MM	9 MM
0088 039 019	D. 3,9 x 19	ZINCATA	3 MM	12 MM
0088 039 025	D. 3,9 x 25	ZINCATA	3 MM	18 MM
0088 039 032	D. 3,9 x 32	ZINCATA	3 MM	25 MM
0088 039 045	D. 3,9 x 45	ZINCATA	3 MM	38 MM

Informazioni Tecniche

Applicazione

**M3,9**

Forma della testa: Testa piana speciale

Impronta Croce

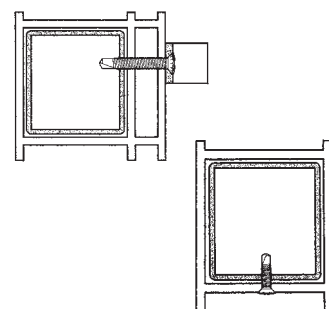
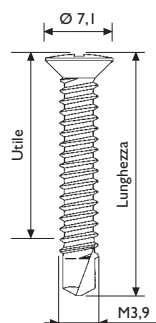

**VITI TESTA SVASATA CALOTTA AUTOFORANTE PER APPLICAZIONI SPECIALI**



CODICE	Ø x L	FINITURA	CAPACITÀ DI FORATURA	LUNGHEZZA UTILE
0088 A42 042	4,2x42MM	ZINCATA	2 MM	23 MM

Informazioni Tecniche

Applicazione

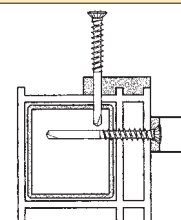
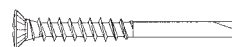

**VITI TESTA SVASATA CALOTTA AUTOFILETTANTI FISSAGGI CHIUSURE E SQUADRI PER PERSIANA ZINCATA NERA 12 MICRON**

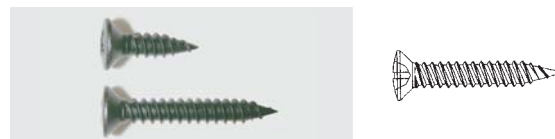

CODICE	Ø x L	FINITURA	LUNGHEZZA UTILE
0079 042 015	D. 4,3 x 15	Zincata nera	9 MM
0079 042 027	D. 4,3 x 27	Zincata nera	21 MM



**VITE TESTA SVASATA CALOTTA AUTOFILETTANTE PER PVC PER FISSAGGIO DELLA FERRAMENTA E DEGLI INCONTRI**

CODICE	Ø x L	FINITURA	LUNGHEZZA UTILE
0078 043 013	D. 4,3 x 13	ZINCATA	7 MM
0078 043 016	D. 4,3 x 16	ZINCATA	10 MM
0078 043 020	D. 4,3 x 20	ZINCATA	14 MM
0078 043 025	D. 4,3 x 25	ZINCATA	19 MM
0078 043 030	D. 4,3 x 30	ZINCATA	24 MM
0078 043 035	D. 4,3 x 35	ZINCATA	29 MM
0078 043 040	D. 4,3 x 40	ZINCATA	34 MM
0078 043 055	D. 4,3 x 55	ZINCATA	49 MM

Informazioni Tecniche

Applicazione

**M4,3**

Forma della testa: Testa piana speciale

Impronta Croce

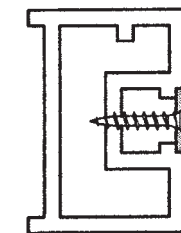
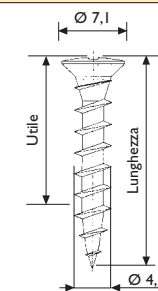

**MÜLLER FISSAGGIO s.a.s.**

Via delle Robinie, 31 - Zona Industriale - 06083 BASTIA UMBRA - (PG/ITALY) - Tel. 075.8004059 - 075.8010841 - Fax 075.8010846 - 075.8014035

www.mullerfissaggio.com - muller@mullerfissaggio.com